

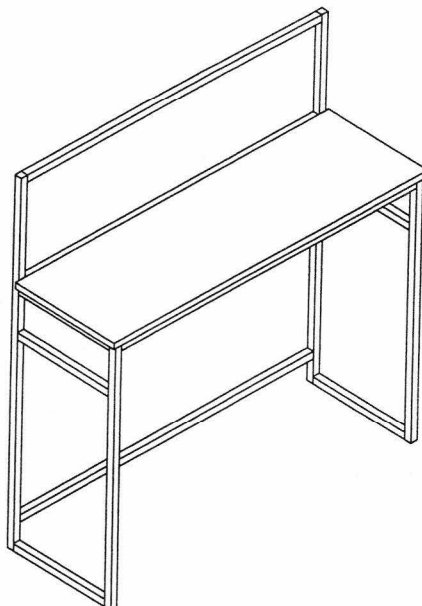









37465

PO# 103674



A M6*35  X 6	B M6*30  X 6	C  X 1	D  X 4	E M6*25  X 2	F  X 2	G  X 1	H  X 1	I  X 1	J  X 1
---	---	---	---	---	---	---	--	---	---

