

|         |          |         |   |
|---------|----------|---------|---|
| 1       | Beschlag |         | 1 |
| 2       | 328*     | 180**   | 1 |
| 3       | 328*     | 180**   | 1 |
| 4       | 1098**   | 326     | 1 |
| 5 glass | 297*     | 130/4   | 8 |
| 6 glass | 1098     | 143/4   | 2 |
| 7 glass | 1088**   | 259**/4 | 1 |
| 8 MDF   | 1098     | 30/30   | 2 |

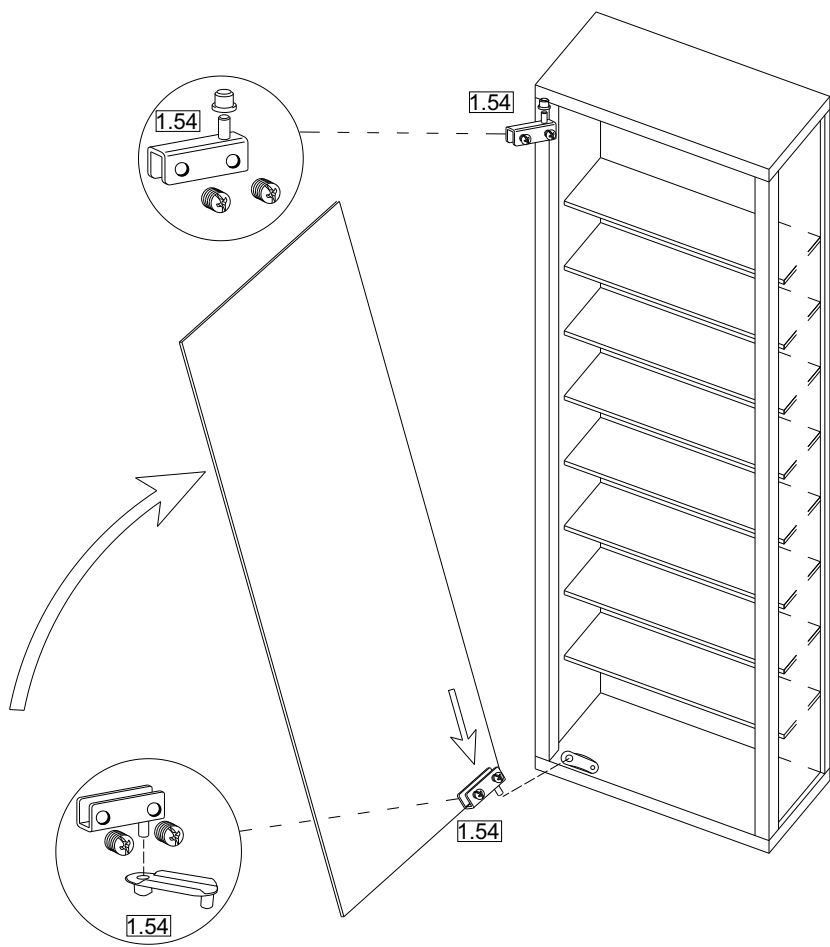

# VCM.







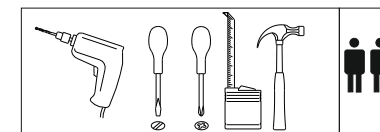
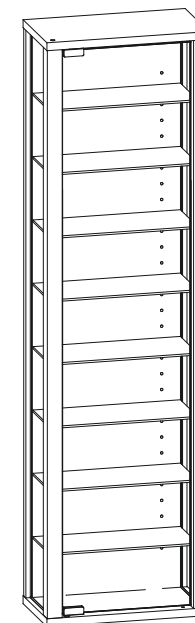

my home

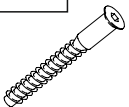
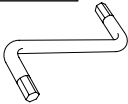
## Aufbauanleitung

Artikel: EDANA MAXI

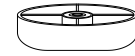
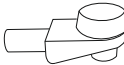
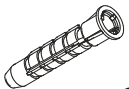

08.02.2019

|   |   |  |  |  |
|---|---|--|--|--|
| 1.7<br><br>x9                    | 1.6<br><br>x1                    | 1.8<br><br>x4   | 1.55<br><br>x1                    | 1.47 <sup>4x25mm</sup><br><br>x4 |
| 1.54<br><br>x1                   | 1.93 <sup>h-15mm</sup><br><br>x4 | 1.78<br><br>x33 |  |  |
| 1.36 <sup>8x40mm</sup><br><br>x2 | 1.95<br><br>x2                   | 1.96<br><br>x2  | 1.5 <sup>3,5x16mm</sup><br><br>x5 |  |

**Unfallgefahr!**

Bitte Artikel unbedingt gegen umkippen sichern!

Wegen verschiedener Wandverhältnisse werden keine Dübel beigefügt.

Bitte Dübel passend zu Ihrer Wand im Fachhandel besorgen!

**Risk of accident!**

Please secure the article against tipping!

Due to different wall conditions no dowels are attached.

Please get dowels suitable for your wall in the specialized trade!

