

VCM.

service@vcm-gruppe.de

Aufbauanleitung

Artikel:

ESILA

Serv. Ref. #041

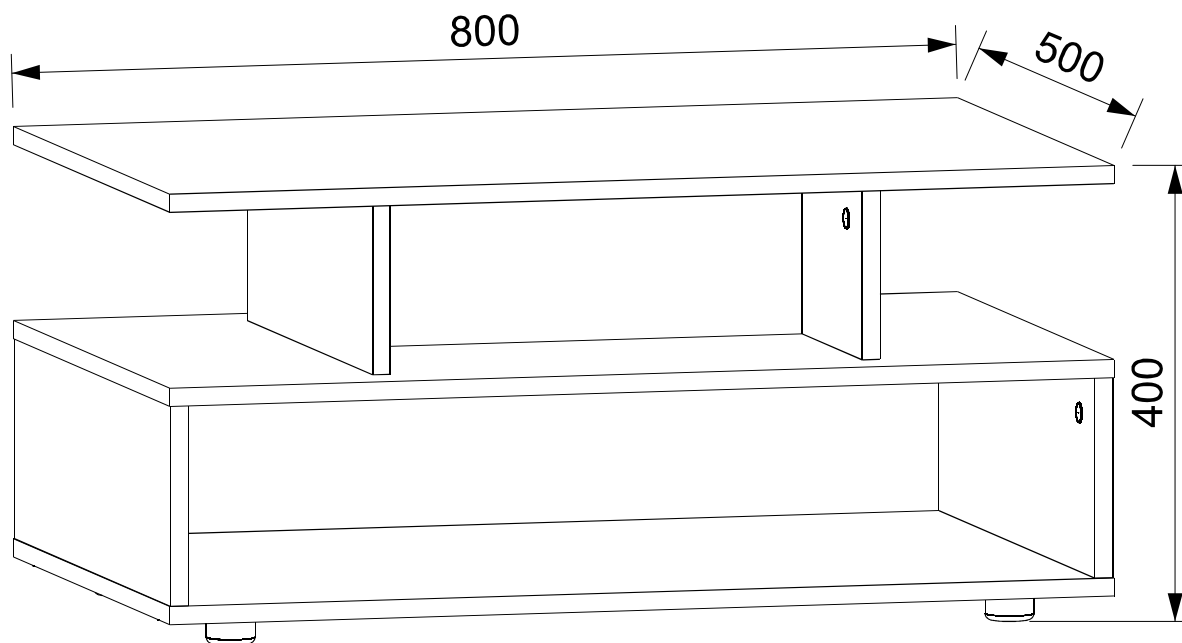

ESILA

No	L	W	Pcs
1	800**	500**	1
2	400	144**	2
3	400	144	1
4	800**	500**	1
5	498	165**	2
6	800**	500**	1

A

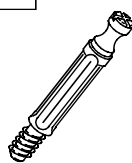

x8

B



x8

C



x8

D

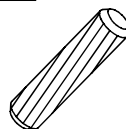

x11

E

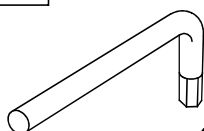

x1

F

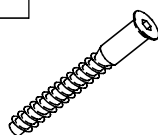

x8

G

3.5x25mm

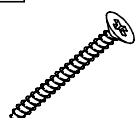

x4

H

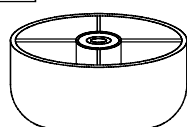

x4

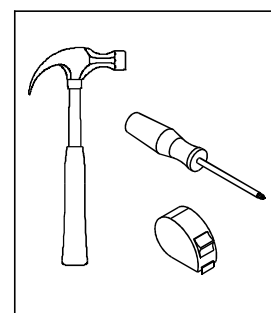

30.07.2020

