

59092

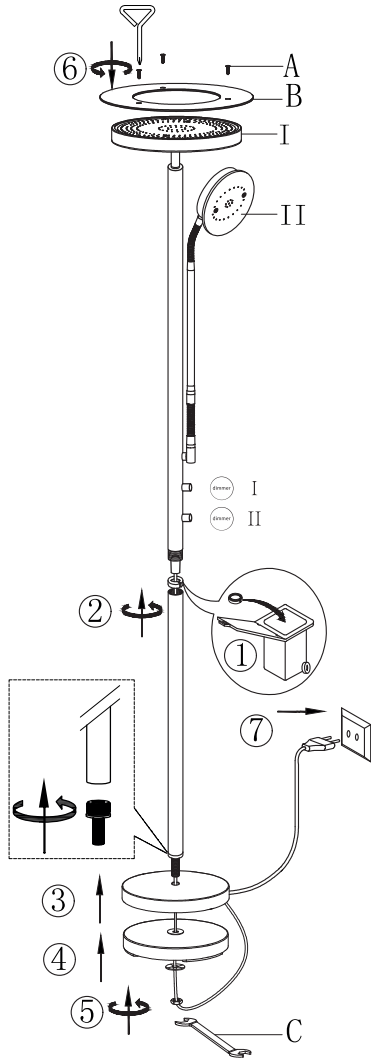

GLOBO Handels GmbH
Gewerbstrasse 3
A-9184 Sankt Peter AUSTRIA

Lichtquelle/Light Source:

DEU:

Lichtquelle:

Die Lichtquelle ist nicht tauschbar, weil sie konstruktionsbedingt fest mit dem umgebenden Produkt verbunden ist.

Dieses Produkt enthält eine Lichtquelle der Energieeffizienzklasse <F>.

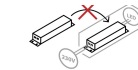

Betriebsgerät nicht austauschbar.



Leuchtmittel nicht austauschbar.

GBR:

Light source:

The light source is not interchangeable because it is determined by the surrounding product design.

This product contains a light source of energy efficiency class <F>.

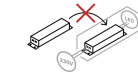

Non replaceable control gear.



Non replaceable light source.

BIH:

Izvor svjetla:

Izvor svjetla nije zamjenjiv, jer je konstrukcijski pričvršćen na proizvod. Ovaj proizvod sadrži izvora svjetlosti klase energetske učinkovitosti <F>.

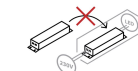

Pogonski uređaj se ne može zamjeniti.



LED žarulje nije moguće zamjeniti

BG:

Източник на светлина:

Източникът на светлина не може да се подменя, тъй като поради конструкцията си е трайно фиксиран към заобикалящия го продукт. Този продукт включва светлинен източник с клас на енергийна ефективност <F>.

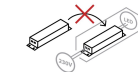

Управляващото устройство не може да се подменя.



Източникът на светлина не може да се подменя.

CZ:

Zdroj světla:

Světelný zdroj není možné vyměnit, protože je díky své konstrukci pevně spojený s produktem. Tento výrobek obsahuje světelný zdroj s třídou energetické účinnosti <F>.

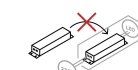

Předřadník není vyměnitelný.



Světelný zdroj není vyměnitelný.

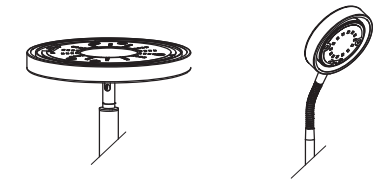

DK:

Lyskilde:

Lyskilden kan ikke udskiftes, fordi den er fast forbundet med det omgivende produkt.

Dette produkt indeholder en lyskilde i energieffektivitetsklasse <F>.

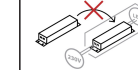

Enheden kan ikke udskiftes.

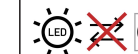

Lyskilden kan ikke udskiftes.

ET:

Valgusallikas:

Valgusallikas ei ole välja vahetatav, sest ta on tootega ehituslikult kindlalt seotud.

Toode sisaldab energiatõhususe klassi <F> valgusallikat.

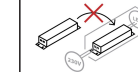

Juhtimiseadis ei ole välja vahetatav.

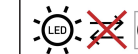

Lamp ei ole välja vahetatav.

FI:

Valonlähde:

Valonlähdettä ei voi vaihtaa uuteen, sillä se on rakenteellisesti yhdistetty ympäröivään tuotteeseen.

Tämä tuote sisältää valonlähteen, jonka energiatehokkuusluokka on <F>.

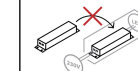

Liitäntälaitetta ei voi vaihtaa.

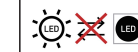

Valonlähdettä ei voi vaihtaa.

FR:

Source lumineuse:

La source lumineuse n'est pas remplaçable car elle est, de par la construction du produit, liée de façon permanente à celui-ci.

Ce produit contient une source lumineuse de classe d'efficacité énergétique <F>.

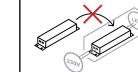

Dispositif de commande non remplaçable.

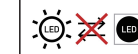

Ampoule non remplaçable.

GR:

Φωτεινή πηγή:

Η φωτεινή πηγή δεν μπορεί να αντικατασταθεί, επειδή είναι για κατασκευαστικούς λόγους σταθερά συνδεδεμένη με το προϊόν που την περιβάλλει.

Το προϊόν αυτό περιέχει φωτεινή πηγή της τάξης ενεργειακής απόδοσης <F>.

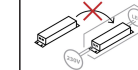

Η διάταξη λειτουργίας δεν μπορεί να αντικατασταθεί.

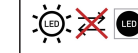

Ο λαμπτήρας δεν μπορεί να αντικατασταθεί.

Lichtquelle/Light Source:

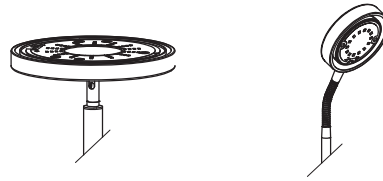

HU:
Fényforrás:
A fényforrás nem cserélhető, mert felépítése miatt szilárdan csatlakozik a termékhez.
Ez a termék egy <F> energiahatékonysági osztályú fényforrást tartalmaz.

 Az előtét nem cserélhető.

 A fényforrás nem cserélhető.

Isländisch/IS:
Ljósjafi:
Ljósjafinn er ekki útskiptanlegur vegna þess að hann er háður umliggjandi hönnun vörunnar.
Varan inniheldur ljósjafa í orkuflökki <F>.

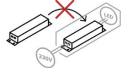
 Ekki útskiptanlegur stýribúnaður.

 Ekki útskiptanlegur ljósjafi.

IT:
Sorgente luminosa:
La sorgente luminosa non è intercambiabile perché è saldamente collegata al prodotto per via del suo design.
Questo prodotto contiene una sorgente luminosa di classe di efficienza energetica <F>.

 Alimentatore non sostituibile.

 Lampadine non intercambiabili.

HR:
Izvor svjetla:
Izvor svjetla nije zamjenjiv, jer je konstrukcijski pričvršćen na proizvod.
Ovaj proizvod sadržava izvor svjetlosti klase energetske učinkovitosti <F>.

 Pogonski uređaj se ne može zamjeniti.

 LED žarulje nije moguće zamjeniti.

LV:
Gaismas avots:
Gaismas avotu nevar nomainīt, jo tas konstrukcijā ir cieši savienots ar izstrādājuma apkārtnē daļu.
Šis ražojums satur gaismas avotu, kura energoefektivitātes klase ir <F>.

 Vadības ierīci nevar nomainīt.

 Apgaismes līdzekli nevar nomainīt.

LT:
Šviesos šaltinis:
Šis šviesos šaltinis yra nekeičiamas, nes jis prijungtas prie gaminio pagal jo konstrukciją.
Šiame gaminyje yra šviesos šaltinis, kurio energijos vartojimo efektyvumo klasė <F>.

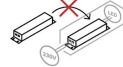
 Valdymo įtaisas yra nekeičiamas.

 Šviesos šaltinis yra nekeičiamas.

NL:
Lichtbron:
De lichtbron kan niet worden vervangen, omdat deze vanwege de constructie vast met het product eromheen verbonden is.
Dit product bevat een lichtbron van energie-efficiëntieklasse <F>.

 Apparaat kan niet worden vervangen.

 Verlichting kan niet worden vervangen.

Norwegisch/Norwegian / NO:
Lyskilde:
Lyskilden kan ikke byttes fordi den sitter fast i produktet.
Dette produktet inneholder en lyskilde i energiklasse <F>.

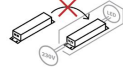
 Driftsapparatet kan ikke byttes ut.

 Lyskilden kan ikke byttes ut.

PL:
Źródło światła:
Źródła światła nie można wymienić, ponieważ jest zintegrowane z produktem ze względu na swoją konstrukcję.
Ten produkt zawiera źródło światła o klasie efektywności energetycznej <F>.

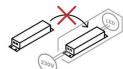
 Osprzętu sterującego nie można wymienić.

 Źródła światła nie można wymienić.

PT:
Fonte de Luz:
A fonte de luz não é substituível porque devido às suas características construtivas está fixada de forma permanente ao produto circundante.
Este produto contém uma fonte de luz da classe de eficiência energética <F>.

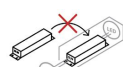
 Dispositivo de comando não substituível.

 Lâmpada não substituível.

Lichtquelle/Light Source:

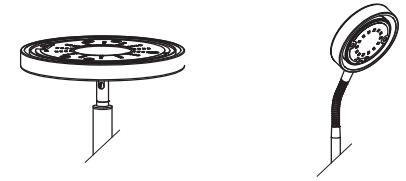

RO:
Sursa de lumina:
Sursa de lumina nu este inlocuibilă ea fiind parte constructivă a produsului.
Acest produs conține o sursă de lumină cu clasă de eficiență energetică <F>.

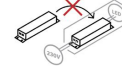
 Unitatea de control nu poate fi schimbată.

 Sursa de lumina nu poate fi schimbată.

RUS:
Источник света:
Источник света не является взаимозаменяемым, поскольку это определяется конструкцией смежного продукта.
Данный продукт содержит источник света класса энергоэффективности <F>.

 Незаменяемый регулировочный механизм.

 Незаменяемый источник света.

SRB:
Izvor svetlosti:
Izvor svetlosti nije zamenljiv, jer je zbog svog dizajna čvrsto povezan sa proizvodom koji ga okružuje.
Ovaj proizvod sadrži izvor svetlosti klase energetske efikasnosti <F>.

 Upravljački uređaj nije zamenljiv.

 Izvor svetlosti se ne može zameniti.

SK:
Zdroj svetla:
Svetelný zdroj nie je možné vymeniť, pretože je vďaka svojej konštrukcii pevne spojený s produktom.
Tento výrobok obsahuje svetelný zdroj triedy energetickej účinnosti <F>.

 Predradník nie je vymeniteľný.

 Svetelný zdroj nie je vymeniteľný.

SI:
Izvor svetlobe:
Vir svetlobe ni zamenljiv, ker je določen z zasnovno izdelka v okolici.
Ta izdelek vsebuje svetlobni vir razreda energijske učinkovitosti <F>.

 Nezamenljiv krmilnik.

 Nezamenljiv vir svetlobe.

ES:
Fuente de luz:
La fuente de luz no es sustituible porque está fija en el producto desde la construcción.
Este producto contiene una fuente luminosa de la clase de eficiencia energética <F>.

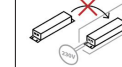
 Dispositivo de control no reemplazable.

 Bombilla no reemplazable.

EN:
Energy efficiency class
Light source:
The light source is not interchangeable because it is determined by the surrounding product design.
Notice for surveillance:
In order to be able to access the light source, decorative elements must be removed; this may involve mechanical damage.
This product contains a light source of energy efficiency class <F>.

 Non replaceable control gear.

 Non replaceable light source.

SE:
Ljuskälla:
Ljuskällan är inte utbytbar, eftersom den på grund av konstruktionen är fast integrerad i den omgivande produkten.
Denna produkt innehåller en ljuskälla med energieffektivitetsklass <F>.

 Driftdonet kan inte bytas ut.

 Ljuskällan är inte utbytbar.

TR:
Işık kaynağı:
Konstrüksiyon gereği çevreylen ürün ile sabit bir şekilde bağlı olduđu için ışık kaynağı deđiştirilemez.
Bu ürün, <F> enerji sınıfından bir ışık kaynağına sahiptir.

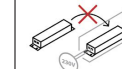
 İşletme cihazı deđiştirilemez.

 Aydınlatma malzemesi deđiştirilemez.

UK:
Джерело світла:
Джерело світла не можна обміняти, оскільки воно міцно пов'язане з навколишнім виробом завдяки своїй конструкції.
Цей виріб містить джерело світла класу енергоефективності <F>.

 Редуктор не є змінним.

 Цібулини не взаємозамінні.