

30288(EK01619C-1)

80788(EK01619-1)

1

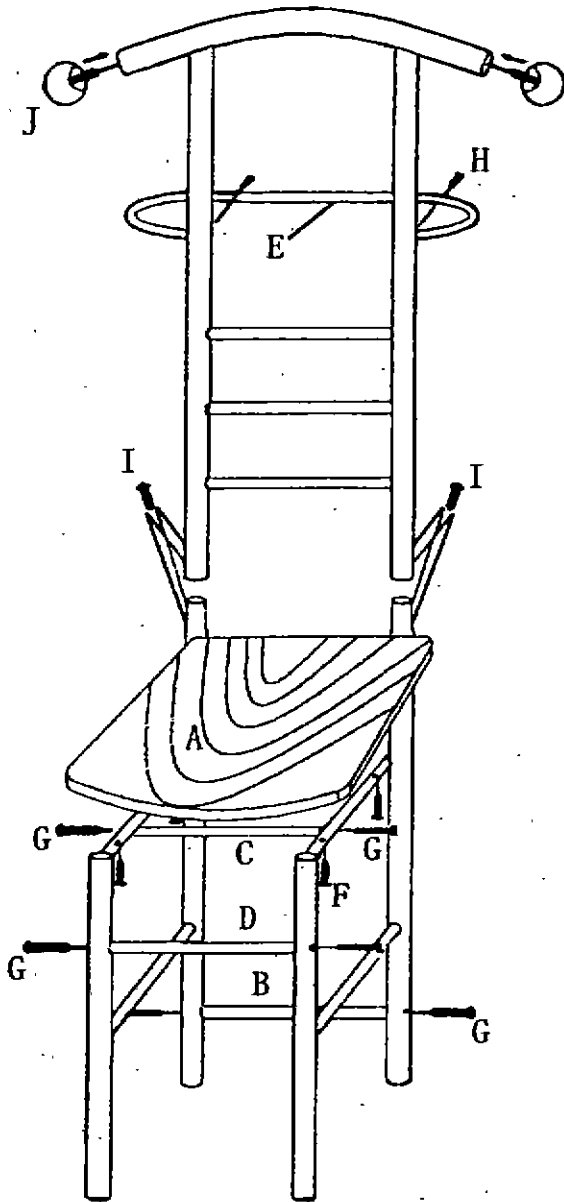

2

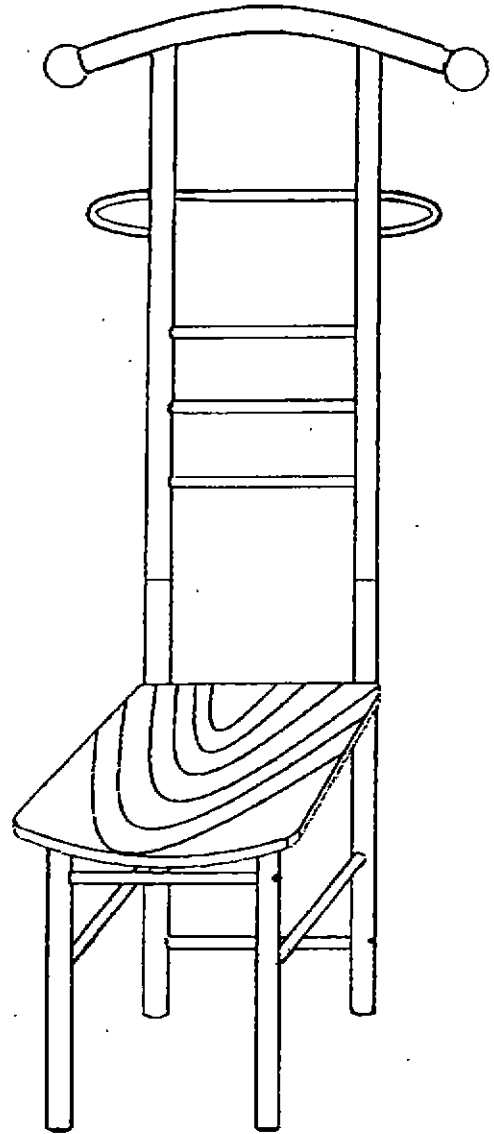

Ax1

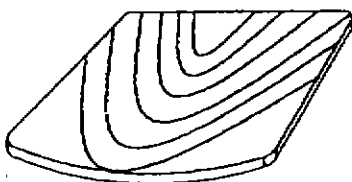

Bx1

210mm

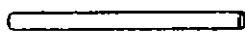

Ex1



Hx2



Cx1

230mm

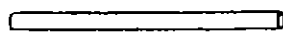

Fx4

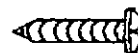

Ix4



Dx1

235mm

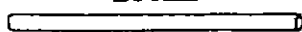

Gx6



Jx2

